

THE NEW RINGSCAFF STAIR TOWER

- **Secure**
- **Robust**
- **Versatile**

The new version of the semi-system-free stair tower does not require any screw connections, has many clever details that make the tower safer and which also extremely simplify assembly.

The new, adaptable staircase access is a further building block for more pedestrian convenience and safety and can also be used extremely flexibly. It can be easily integrated into façade and modular projects, but also does excellent justice to itself when used as a stand-alone escape stair tower solution.

MAIN ADVANTAGES AT A GLANCE

- Use as main escape route possible
- Variable access widths, as system decks are used as steps
- Variable exit heights through use of the system-independent universal stair stringers
- Extensive use of existing material, few additional components.

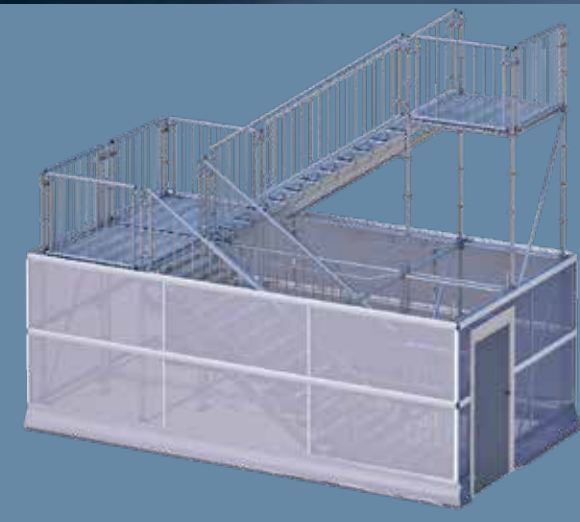

CALCULATOR, NEWS + MANUALS

You can access approval documents, technical details and manuals on our website with the APP. Our animations and current scafom-rux news are also available there.

So it is probably a good idea to surf over to the iOS or Android store and download the scaffold APP from there! Free of charge and without any in-app purchases.

QUICK ON-THE-SPOT ESTIMATE? APP-SOLUTELY NO PROBLEM!

Who doesn't know the situation: an impromptu enquiry and the customer is located along the way, so drive over quickly and have a look at the situation. Then the typical question: "Well, what sort of price can I expect?". You will always have the answer right in your pocket: namely your smartphone with our scaffold APP. **This enables you to quickly calculate the parts needed for a façade or modular scaffolding as well as stair towers.** A few seconds later the customer has a general idea of the cost and you already have a rough parts list. You could even email us this list directly and make an order out of it. Not exactly unselfish, but still ingenious, isn't it?

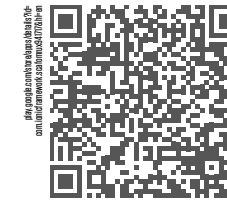
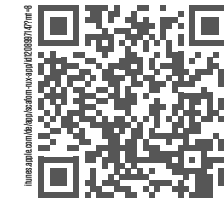

SORTED BY PRODUCT GROUPS, OPTIMISED FOR ALL DEVICES: VIMEO.COM/RUXGMBH/ALBUMS

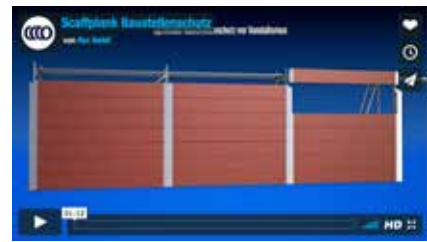

E.g. SCAFFPLANK building site protection: Protection against vandalism and noise as well as for passers-by during demolition work can be simply implemented through the use of standard planking that is just inserted into the system-independent SCAFFPLANK rails.



E.g. SCAFFGUARD scaffold cladding: Economic, system-independent enclosures – and that with a minimal storage requirement. Building sites with scaffolding can be cladded very simply using SCAFFGUARD. System-independent!



All SMART DETAILS price lists with lots of additional information and application examples can be downloaded free of charge from our homepage at <https://www.scafom-rux.de/de/resources/downloads>.

MORE INFO? SMART DETAILS!

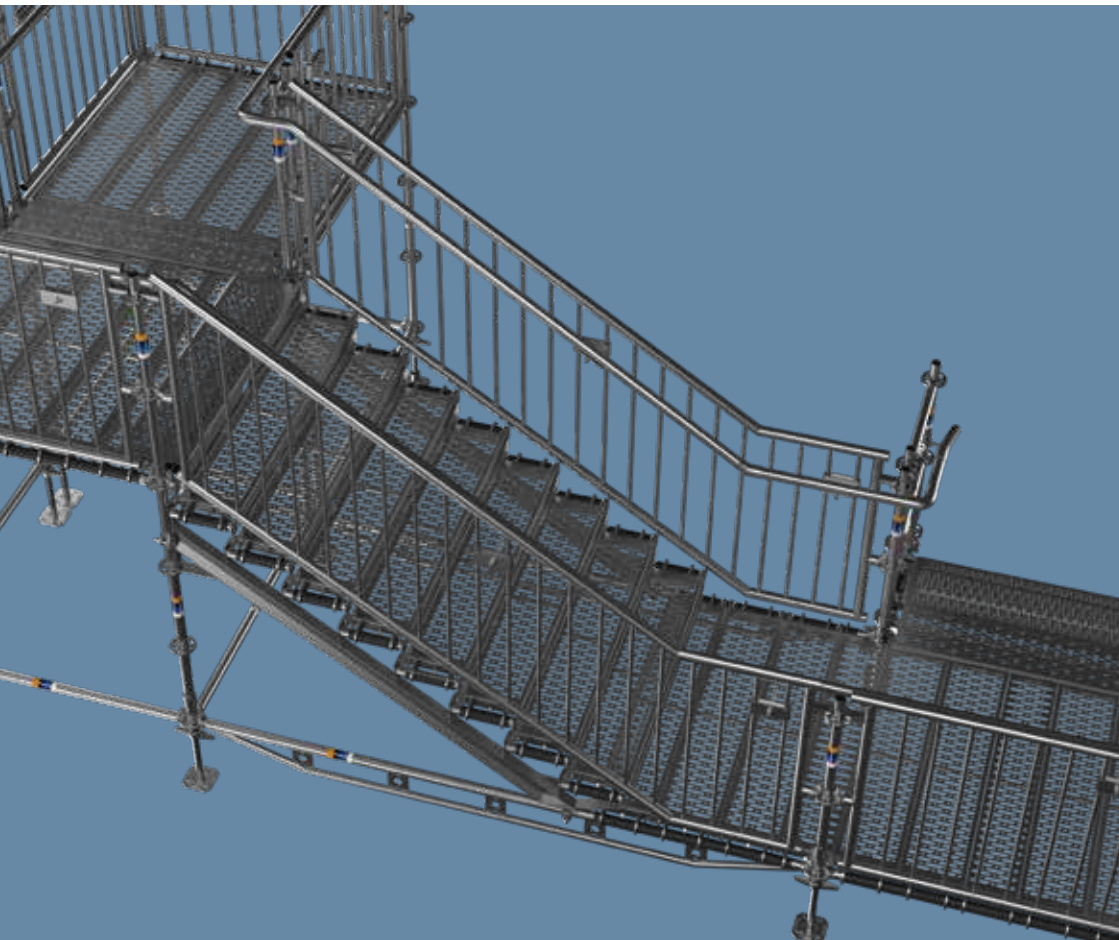

Building something completely different from a standard component ... creating completely new solutions with just a few new components. That is our sustainability contribution at Scafom-rux. MULTI-USE is the smart way to save capital and capacity with immediate effect and still achieve more.



ULTRA-QUIET AND CHILDPROOF RINGSCAFF STAIR TOWER

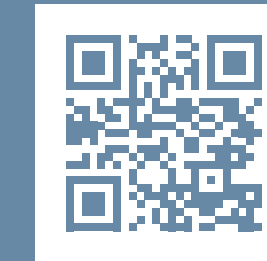

SMART CLIP



TECH-INFO MODULAR SCAFFOLDING RINGSCAFF | 2022-10-EN

APPLICATION

In case of danger, many people have to be evacuated in a short period of time when used as emergency stairs. A stair tower needs to function 100%. Nothing can be in the way, every detail counts. The new RINGSCAFF stair tower comes with many new ideas that make our stair solutions even better.

TRAFFIC LOAD	up to 7.5 kN/m ²
STAIR WIDTH	variable from 1.00 m to 2.07 m
STEP HEIGHT	16.60 cm
SYSTEM COMPATIBILITY	Modular scaffolding RINGSCAFF, suitable as stair tower front structure for all scaffolds
CLASSIFICATION	Meets the requirements of the German Regulations on Places of Assembly
APPROVAL	Scaffolding construction out of RINGSCAFF, approval No. Z-8.22-869



The concept of the Scafom-rux universal stair tower is based on a 12- to 24-leg scaffold base and meets the increased requirements resulting from the German Regulations on Places of Assembly.

Sometimes it is necessary to react flexibly to local conditions on site. Since the universal stair stringer allows exits in 50 cm increments and various bay heights can be combined with each other, the installation team can realise almost any exit height. Dismantling towers to make corrections on site thereby becomes a thing of the past.

UNIVERSAL STAIR STRINGER
FLEXIBLE IN HEIGHT

The height gradation of **0.50 / 1.00 / 1.50** or **2.00** metres is freely selectable on each level and facilitates object-related adaptation for accesses at different heights.

This means that the stair height can always be adapted to the conditions. A subsequent change in the scaffolding is also possible.



Flexible:
The base plate remains free during assembly of the stair stringer and is thus available for important connections such as ledgers and diagonals.

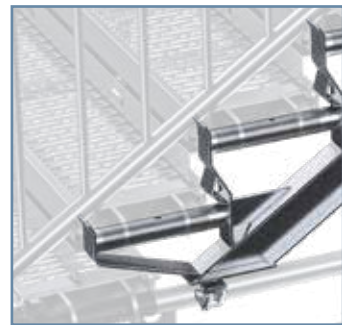

Individual:
The lower support of the stair stringer is placed directly on the ledger. This means that the same ledger can be used for all stringer heights. Covered with steel decks or planks for tube hook-up.



UNIVERSAL STAIR STRINGER

Proven: The universal stair stringer is still the core of the stair tower solution. Exits can be flexibly implemented in the 50 cm grid. And as a bonus: various stair heights can be combined. Structural situations can be addressed flexibly with RS-TRT.

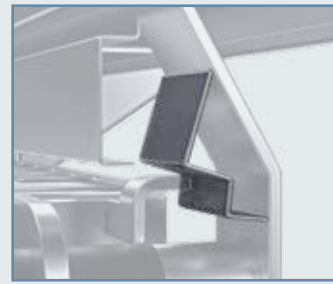

New:
By changing the geometry, the deck retainer is now system-integrated.

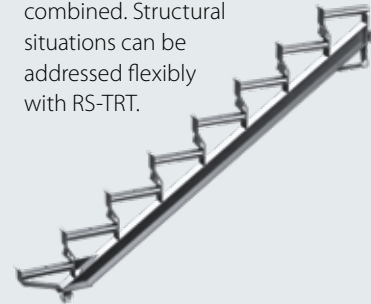

WEDGE-HEAD GUARDRAIL

Even the largest guardrail types can be fitted by one person by simply hooking them in. A hammer blow and the RINGSCAFF wedge connection is in place.



Additional convenience: Handrails for adults and children incl. More safety: Standardised struts are specially designed for child safety.



FOOTFALL SOUND INSULATION

New:
Reduces most of the movement noise caused by passers-by. A simple solution with a great external impact and one that will be indispensable in the future.

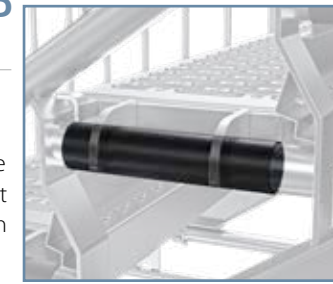

CLEVER LEDGERS

New:
Gaps are covered by smart ledger connections - without bolts. And that in the area of the steps as well as on the platforms of the towers. There are no tripping hazards.

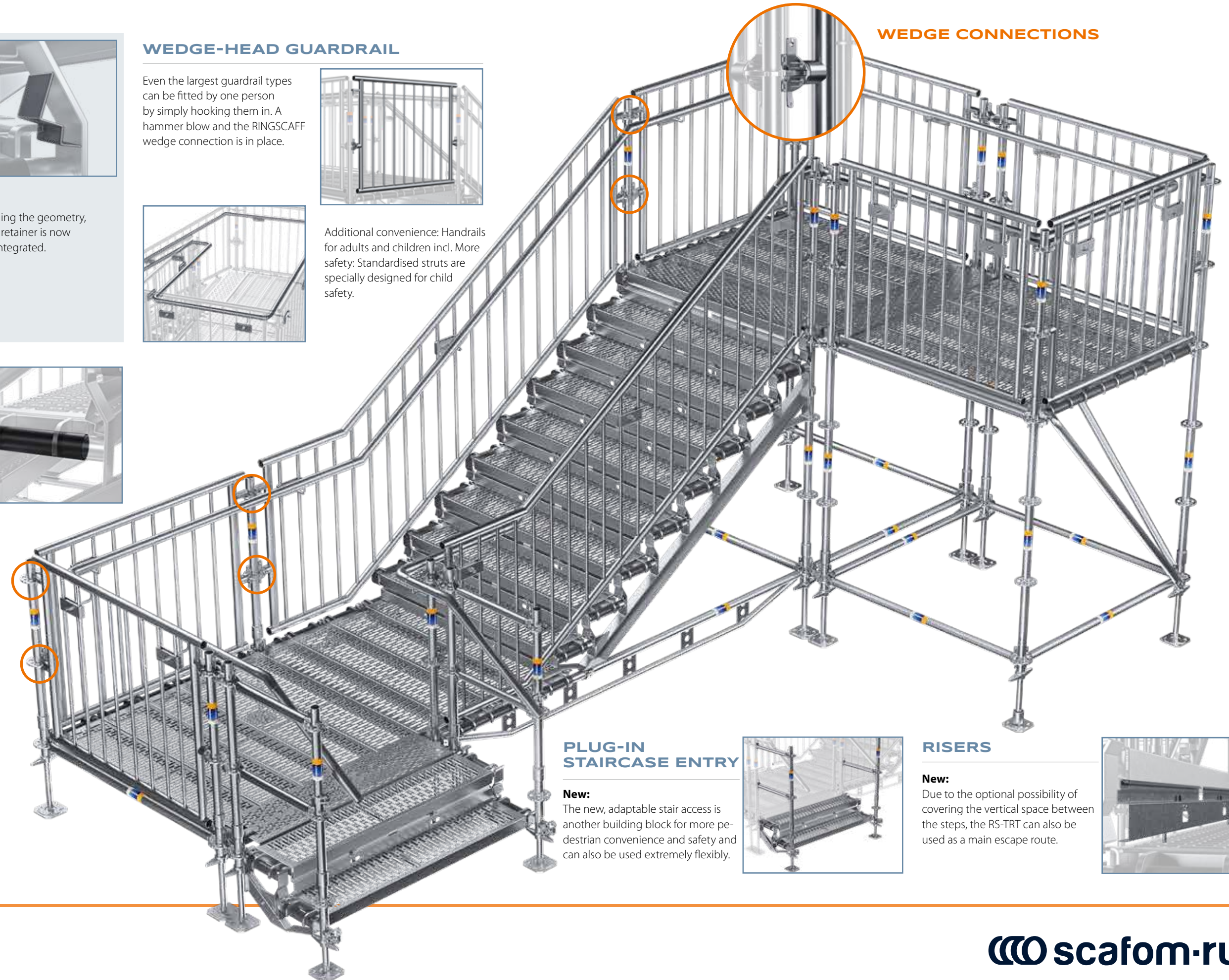

WEDGE CONNECTIONS

PLUG-IN STAIRCASE ENTRY

New:
The new, adaptable stair access is another building block for more pedestrian convenience and safety and can also be used extremely flexibly.



RISERS

New:
Due to the optional possibility of covering the vertical space between the steps, the RS-TRT can also be used as a main escape route.

